

PRO
SERIES **P**

AES

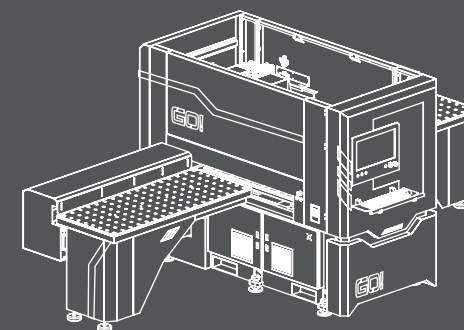

EN
TR
ES



GO!

Making its first overseas investment in the USA as the flagship of the Turkish woodworking machinery industry, AES continues to serve its customers in the North and South America through its center that was launched in Charlotte, North Carolina to provide sales and aftersales services.

Türk ahşap işleme sektörünün bayrak taşıyıcı firması olarak, ABD'de ilk yurt dışı yatırımını yapan AES satış ve satış sonrası hizmetleri için N.Carolina/Charlotte'da aktif hale getirdiği merkezi ile, Kuzey ve Güney Amerika'da hizmet vermeyi sürdürmektedir.

Haciendo su primera inversión en el extranjero en los EE.UU. como el buque insignia de la industria de maquinaria de carpintería turca, AES continúa sirviendo a sus clientes en América del Norte y del Sur a través de su centro que se inauguró en Charlotte, Carolina del Norte para brindar servicios de ventas y posventa.

As part of its policy to expand its sales and aftersales service network on an ongoing basis, AES has incorporated its affiliate AES Europe in Bilzen, Belgium with a view to providing better sales and aftersales services as well as technical support to its customers in Europe

Avrupa kıtasındaki müşterilerine daha iyi satış ve satış sonrası hizmet verebilmek amacıyla Bilzen/Belçika'da AES Europe'u kurdu. AES, müşterilerine teknik destek sağlarken satış ve servis ağını da her geçen gün büyümeye devam etmektedir.

Con el fin de brindar un mejor servicio de venta y posventa a sus clientes en el continente europeo, AES que estableció AES Europe en Bilzen/Bélgica, mientras brinda soporte técnico a sus clientes, continúa expandiendo su red de ventas y servicio día a día.

AES GROUP, which has re-defined the sector with the machines and designs it has developed in the Woodworking Machinery sector since the first day it was founded in 1989; it is the flag carrier company of Turkey in the sector. AES, which always continues to be your global partner with its high production capacity, expert staff, global sales and service network, grows with you and continues to develop while growing, with the centers it opened and the service network it established to become one of the world's leading manufacturers in line with its founding vision.

1989 yılında, kurulduğu ilk günden bu yana Ahşap İşleme Makineleri sektöründe geliştirdiği makineler ve tasarımlarla sektörü yeniden tanımlayan AES GROUP; Türkiye'nin sektördeki bayrak taşıyıcı firması konumundadır. Yüksek üretim kapasitesi, uzman kadrosu, küresel satış ve servis ağı ile her zaman global partneriniz olmaya devam eden AES, kuruluş vizyonu doğrultusunda, dünyanın sayılı üreticileri arasında girmek için açtığı merkezler ve kurduğu hizmet ağı ile; sizlerle büyüyor, büyürken de geliştirmeye devam ediyor.

GRUPO AES, que ha redefinido el sector con las máquinas y diseños que ha desarrollado en el sector de la Maquinaria para la Madera desde el primer día de su fundación en 1989; Es la compañía aérea de bandera de Turquía en el sector. AES, que siempre sigue siendo su socio global con su alta capacidad de producción, personal experto, red global de ventas y servicio, crece con usted y continúa desarrollándose mientras crece, con los centros que abrió y la red de servicio que estableció para convertirse en uno de los principales fabricantes del mundo en consonancia con su visión fundacional.

your global partner

AES Group: It grows with you with the goal of becoming a global brand and continues to produce and develop while growing. AES UK continues its Sales and After-Sales Service services in the UK, Ireland, Northern Ireland, Scotland and Wales regions.

AES Group; küresel bir marka olma hedefi ile sizlerle büyümekte, büyürken de üretmeye ve geliştirmeye devam etmektedir. AES UK firması ile Britanya, İrlanda, Kuzey İrlanda, İskoçya ve Galler bölgelerinde Satış ve Satış Sonrası Servis hizmetlerini sürdürmektedir.

Grupo AES; Crece contigo con el objetivo de convertirse en una marca global y continúa produciendo y desarrollándose mientras crece. AES UK continúa con sus servicios de Ventas y Servicio Posventa en las regiones del Reino Unido, Irlanda, Irlanda del Norte, Escocia y Gales.



1300
1300 x ∞ mm

1300 M/S
1300 x ∞ mm

1300 M/S ATC
1300 x ∞ mm

Top quality professional solutions

Üstün kalite, profesyonel çözümler
Calidad superior, soluciones profesionales

EN

PRO series machines are our product group that combines fast and precise results with energy saving in your mass production processes. PRO Series, which offers economy and professionalism as a whole for developing and changing market conditions, was created by combining quality and performance in the R-D process with a cost-effective strategy taking into account your investment costs in production.

TR

PRO serisi makineler, seri üretim işlemlerinizde hızlı ve hassas sonuçları, enerji tasarrufu ile birleştiren ürün grubumuzdur. Gelişen ve değişen piyasa koşulları için ekonomi ile profesyonelliği bir bütün halinde sunan PRO Serisi, üretim süreçlerinizde yatırım maliyetlerinizi göz önünde bulundurarak AR&GE sürecinde kalite ve performansın uygun maliyet stratejisi ile birleştirilmesiyle oluşturuldu.

ES

Las máquinas de la serie PRO son nuestro grupo de productos que combina resultados rápidos y precisos con el ahorro de energía en sus procesos de producción en masa. La serie PRO, que ofrece economía y profesionalidad en su conjunto para desarrollar y cambiar las condiciones del mercado, se creó combinando la calidad y el rendimiento en el proceso de I+D con una estrategia rentable que tiene en cuenta sus costos de inversión en producción.herramientas automáticas.



Challenge Your Performance

GO! CNC drilling machine is much more than a standard drilling machine with high operating speeds, excellent part accuracy and equipment that guarantees high-end performance. GO! In addition to standard drilling operations, it allows you to perform seating, 3D surface treatment, special connection operations with aggregate in a single machine. With the parametric program running on the machine, you can implement your designs in the easiest way.

GO! hat delik makinesi yüksek çalışma hızları, mükemmel parça hassasiyeti ve üst seviye performansı garanti eden ekipmanları ile standart bir delik makinesinin çok daha fazlası. GO! standart delik operasyonlarına ek olarak ebatlama, 3D yüzey işleme, aggregate ile özel bağlantı işlemlerinizi tek bir modelde yapmanıza olanak sağlar. Makine üzerinde çalışan parametrik program ile tasarımlarınızı en kolay şekilde hayata geçirebilirsiniz.

GO! La máquina de perforación CNC es mucho más que una máquina de perforación estándar con altas velocidades de operación, excelente precisión de piezas y equipos que garantizan un rendimiento de alta gama. ¡Ir! Además de las operaciones de perforación estándar, le permite realizar asientos, tratamiento de superficies 3D, operaciones especiales de conexión con agregados en una sola máquina. Con el programa paramétrico ejecutándose en la máquina, puede implementar sus diseños de la manera más fácil.



KITCHEN



OFFICE
FURNITURE



CLOSET ROOM



FURNITURE



KITCHEN



BATHROOM

CABINET

Beyond your priorities

Önceliklerinizden fazlası
Más alla de sus prioridades

PERFECT RESULTS IN MILLING APPLICATIONS

FREZE UYGULAMALARINDA MÜKEMMEL SONUÇLAR

EXCELENTES RESULTADOS EN LAS APLICACIONES DE FRESADO

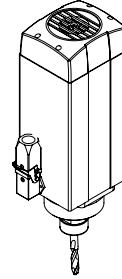

EN

With its high-performance spindle motor, it guarantees excellent results in all your routing applications, including 3D applications.

TR

Yüksek Performanslı Freze motoru ile 3D uygulamaları dahil tüm freze uygulamalarında mükemmel sonuç garanti eder

ES

Con su motor de fresado de alto rendimiento, garantiza excelentes resultados en todas sus aplicaciones de fresado incluidas las aplicaciones 3D.

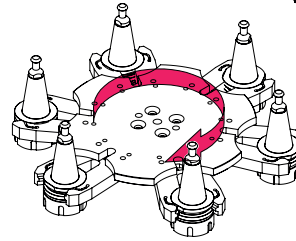

EN

Automatic tool change unit with 6 tool capacity keeps different types of tools ready for quick and easy change

TR

6 Takım kapasiteli otomatik takım değiştirme ünitesi farklı tip takımları hızlı ve kolay değiştirmek için hazır tutar

ES

Unidad para cambiar las herramientas automático con capacidad para 6 equipamientos mantiene listas las diferentes tipos de herramientas para un cambio rápido y fácil

MULTIWAY USE WITH AUTOMATIC TOOL CHANGE UNIT

OTOMATİK TAKIM DEĞİŞTİRME ÜNİTESİ İLE ÇOK YÖNLÜ KULLANIM

USO VERSÁTIL CON LA UNIDAD DE CAMBIO AUTOMÁTICO DE HERRAMIENTAS



BORING UNIT

ÇOKLU DELİK ÜNİTESİ

UNIDAD DE ORIFICIOS MÚLTIPLES

Shorten your lead time with customized drilling unit options

EN

İhtiyaçlarınıza göre şekillendirilebilen delik ünitesi seçenekleri ile üretim sürecinizi kısaltın.

TR

Acorte su proceso de producción con opciones de unidades de orificios que pueden moldearse según sus necesidades.

ES

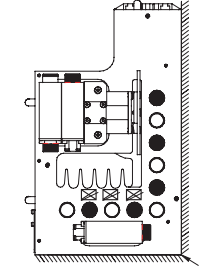
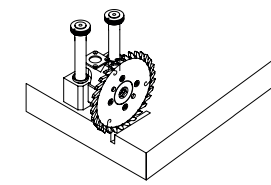
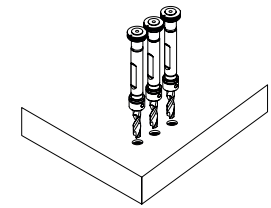
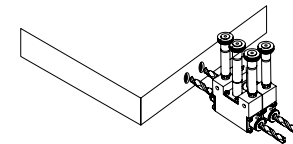
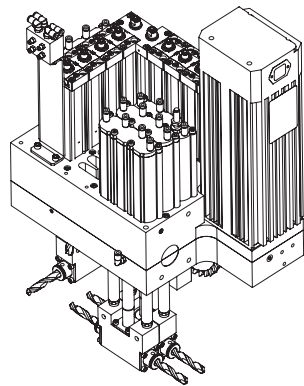

CENTRAL LUBRICATION UNIT
Lubricates the machine at 13 different lubrication points automatically.

MERKEZİ YAĞLAMA ÜNİTESİ
13 farklı bölgede otomatik olarak yağlama sağlar.

UNIDAD CENTRAL DE LUBRICACIÓN
Proporciona lubricación automática en 13 zonas diferentes.



AXIS CONTROL WITH SERVO MOTORS
State of the art motors located on each axis ensure precise acceleration at high speed

SERVO MOTORLAR İLE EKSEN KONTROLÜ
Tüm eksenlerde bulunan son teknoloji ürünü motorlar, yüksek hızlarda hassas ivmelenme sağlar

CONTROL DE EJES CON SERVOMOTORES
Los motores de última generación en todos los ejes proporcionan una aceleración precisa a altas velocidades



HIGH-QUALITY RACK & RAIL
Low-vibration, dynamic & high-quality rails and knemeyer are used to provide the best results at high speeds.

YÜKSEK KALİTE KREMAYER VE RAY
Yüksek hızlarda en iyi sonuç için düşük titreşim sağlayan dinamik, yüksek kaliteli ray ve kremayerler kullanılmaktadır.

CALIDAD EXCELENTE CARRIL DE CREMALLERA
Inin vibraciones bajas para mejores resultados a altas velocidades. Se utilizan rieles y racks dinámicos y de alta calidad. Estructura corporal

PRECISE POSITIONING

HASSAS POZİSYONLAMA

POSICIONAMIENTO SENSIBLE

EN

Perform the positioning of the part in the most precise way with the double gripper controller with the help of independent servo motors.

TR

Bağımsız servo motorlar yardımıyla kontrol edilen çift tutucu ile parça pozisyonlamasını en hassas şekilde yapın.

ES

Realice el posicionamiento de la pieza de la manera más precisa con el agarre doble controlado con la ayuda de servomotores independientes



Processing Unit
İşleme Ünitesi
Unidad De Procesamiento

Designed for perfect Processing

Kusursuz İşleme İçin Tasarlandı
Diseñado para un procesamiento perfecto

EN

The upper pressure group and pressure cylinders enable precise processing by fixing parts in drilling and routing applications.

TR

Üst baskı grubu ve baskı silindirleri delik ve freze uygulamalarında parça sabitlemesini yaparak hassas işleme imkanı verir.

ES

El grupo de presión superior y los cilindros de presión permiten el procesamiento preciso mediante la fijación de piezas en aplicaciones de agujeros y fresado

WIDE MACHINING AREA GENİŞ İŞLEME ALANI

GRAN ÁREA DE PROCESAMIENTO

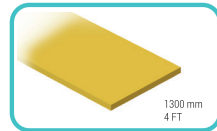

1300 mm
4 FT

AIR FLOATING WORKING TABLE

HAVA YÜZDÜRMELİ ÇALIŞMA TABLASI

PLATAFORMA DE TRABAJO DE FLOTACIÓN EN AIRE

EN

Process your different types of designs easily thanks to the 1300mm processing zone and the part feeding feature from both sides. Perform drilling and milling applications on 5 sides of the part

TR

1300 mm işleme alanı ve her iki taraftan parça besleme özelliği sayesinde farklı tip tasarımlarınızı kolay bir şekilde işleyin. Parçanın 5 tarafında delik ve freze uygulamalarını gerçekleştirin.

ES

Procese sus diferentes tipos de diseños fácilmente gracias a la zona de procesamiento de 1300 mm y la característica de alimentación de piezas desde ambos lados. Realice aplicaciones de perforación y fresado en 5 caras de la pieza.

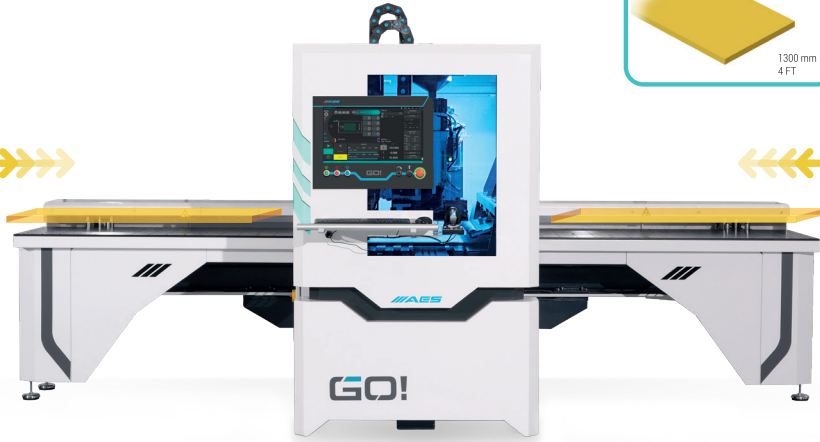



NEXT GENERATION CNC CONTROL UNIT

YENİ JENERASYON CNC KONTROL ÜNİTESİ

UNIDAD DE CONTROL CNC DE ÚLTIMA GENERACIÓN

EN

The next generation control unit is powered by a PC designed for industrial operations. It allows you to make your transactions quickly and easily without getting stuck.

TR

Endüstriyel işler için üretilen PC'den gücünü alan yeni jenerasyon kontrol ünitesi. İşlemlerinizi tıklamadan, hızlı ve kolay gerçekleştirmenizi sağlar.

ES

Unidad de control de nueva generación alimentada por PC fabricada para trabajos industriales. Le permite realizar sus transacciones de forma rápida y sencilla sin quedarse atascado.

USER FRIENDLY INTERFACE

KULLANIMI KOLAY ARAYÜZ

INTERFAZ FÁCIL DE USAR



USER EXPERIENCE / KULLANICI DENEYİMİ / EXPERIENCIA DE USUARIO



"As easy to use as a mobile phone"

"Telefon kullanmak kadar kolay."

"Tan fácil como usar un teléfono"

"The machine helps us to perform machining operations accurately by guiding us with warning messages."

"Uyarılar bizi yönlendirerek, doğru işlem yapmamıza destek oluyor."

"Las alertas nos orientan y nos ayudan a realizar la acción correcta."

Our aftersales support team is always there for you when you need them thanks to the remote control feature of GO!

GO! uzaktan kontrol özelliği ile, ihtiyaç duyduğunuz her an satış sonrası destek ekibimiz yanınızda

Gracias a la función de control remoto de GO! nuestro equipo de soporte posventa le apoya siempre que lo necesite.



7

LANGUAGE 7 DİL SEÇENEĞİ OPCIONES DE 7 IDIOMAS

TR / EN / AR / RU / ES / FR / NL

AW

AES WOP

Design freely



SIMPLY CREATE SMART DESIGNS

BASİTÇE, AKILLI TASARIMLAR OLUŞTURUN

SIMPLEMENTE, CREE DISEÑOS INTELIGENTES

MACHINE AND PARTS SIMULATION

MAKİNE VE PARÇA SİMÜLASYONU

BIBLIOTECA PARAMETRICA

- EN** With the machine and part simulation feature, check your designs before producing and minimize production errors
- TR** Makine ve parça simülasyon özelliği ile tasarımlarınızı üretmeden önce kontrol edin ve üretim hatalarını minimuma indirin.
- ES** Con la función de simulación de piezas y máquinas, verifique sus diseños antes de producir y minimice los errores de producción.

EN

With its parametric design feature, AES WOP CAD/CAM program has been prepared to meet all your design needs. Its easy-to-use interface and advanced features allow you to prepare flexible and fully functional designs.

TR

Parametrik tasarım özelliği ile AES WOP CAD/CAM programı tüm tasarım ihtiyaçlarınızı karşılayacak şekilde hazırlanmıştır. Kullanımı kolay arayüzü ve gelişmiş özellikleri, esnek ve tam işlevsel tasarımlar hazırlamanızı sağlar.

ES

Con su función de diseño paramétrico, el programa CAD/CAM AES WOP ha sido preparado para satisfacer todas sus necesidades de diseño. Su interfaz fácil de usar y sus funciones avanzadas le permiten preparar diseños flexibles y completamente funcionales.

PARAMETRIC LIBRARY

PARAMETRIC KÜTÜPHANE

BIBLIOTECA PARAMETRICA

EN

Change your designs with one click with the parametric module. Save ready-made modules in your library and reuse. Complete the most difficult and complex drawings in minutes with its advanced parametric structure.

TR

Parametrik modül ile tasarımlarınızı tek tıklama ile değiştirin. Hazır modülleri kütüphanenize kayıtlı edin ve tekrar kullanın. Gelişmiş parametrik yapısı ile en zor ve karmaşık çözümleri dakikalar içerisinde tamamlayın.

ES

Cambia tus diseños con un clic con el módulo paramétrico. Guarde los módulos listos para usar en su biblioteca y reutilice los según sea necesario. Complete los dibujos más difíciles y complejos en minutos con su estructura paramétrica avanzada.



DESIGN
TASARLA
DISEÑO



TRANSFER
TRANSFER ET
TRANSFERIR



PRODUCE
ÜRET
PRODUCCIÓN



TECHNICAL INFORMATION

TEKNİK ÖZELLİKLER

ESPECIFICACIONES TÉCNICAS

DIMENSIONS ÖLÇÜLER DIMENSIONES		L	W	H
GO! 1300	mm / inch	4510 / 177.5	2830 / 111.4	2200 / 86.6
GO! 1300 M/S	mm / inch			
GO! 1300 M/S ATC	mm / inch			

TECHNICAL INFORMATION TEKNİK ÖZELLİKLER ESPECIFICACIONES TÉCNICAS	GO! 1300	GO! 1300 M/S	GO! 1300 M/S ATC
X Axis Dimensions X Eksen Ölçüleri La medidas del eje X		160 mm 6.29"	∞
Y Axis Dimensions Y Eksen Ölçüleri La medidas del eje Y		50 mm - 1300 mm 1.96" - 51.18"	
Z Axis Distance Z Eksen Ölçüleri Z-As Abstand		6 - 60 mm 0.23" - 2.36"	
Boring Unit Çoklu Delik Ünitesi Unidad de Herramientas		10 V - 3x2H - 1S	
Spindle Motor Power Spindle Motor Gücü Spilmotorvermogen	-	5.5 kW (8 HP) ER32 Manuel	5.5 kW (8 HP) ISO 30 9 kW - 12HP HSK F63
Magazin Unit Magazin Ünitesi Unidad De Herramientas	-		6 Pcs
Axis Speeds Eksen Hızları Las velocidades del eje		100-100-20 m/min 3937-3937-787 IPM	
Software Yazılım Software		AES WOP	
Installed Power Kurulum Gücü Potencia Ins Talada	10 kW 13 HP	16 kW 21 HP	18 kW 24 HP
Weight(Aproximative) Ağırlık(vakılaşık) El Peso(Aproximativo)	2500 kg 5512 lbs	2600 kg 5732 lbs	2650 kg 5842 lbs

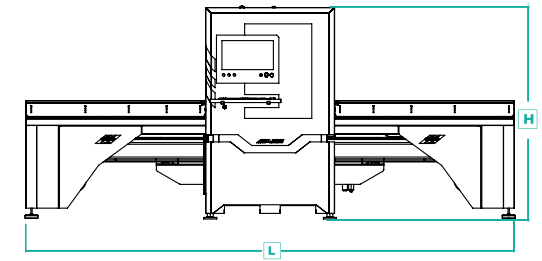
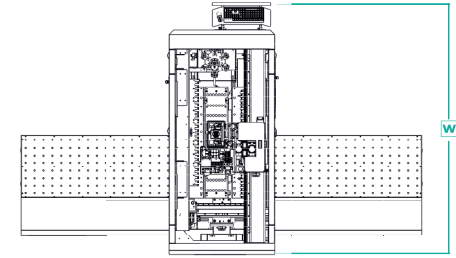

* The technical specifications and drawings provided in the catalogue are non-binding. Stock images and drawings may contain optional equipment. AES Group reserves the right to make amendments without notice.
 * Katalogda bulunan teknik özellikler ve çizimler bağlayıcı değildir. Bazı fotoğraflar ve çizimler opsiyonel ekipmanları içerebilir. AES Group bilgilendirme yapmaksızın değişiklik yapma hakkını saklı tutmaktadır.
 * Las especificaciones técnicas y dibujos del catalogo no son vinculantes. Algunas fotos y dibujos pueden incluir equipamientos opcionales. Grupo AES se reserva el derecho de realizar cambios sin previo aviso.

ALWAYS WITH YOU DAİMA YANINIZDA SIEMPRE CON USTED

EN

Our expert after-sales service staff is 24/7 at your service for all your needs. For your permanent satisfaction, it provides an accurate diagnosis and intervention to all your problems as soon as possible with both instant remote connection support and on-site service. AES GROUP protects your investments with after-sales services for uninterrupted production.

TR

Uzman satış sonrası hizmet kadromuz, tüm ihtiyaçlarınız için 7 gün 24 saat hizmetinizdedir. Daimi memnuniyetiniz için, gerek anlık uzak bağlantı desteği ile gerekse de yerinde servis hizmeti ile en kısa sürede, tüm sorunlarınıza doğru teşhis sağlayarak müdahale sağlamaktadır. AES GROUP, kesintisiz üretim yapmanız için sunduğu satış sonrası hizmetler ile yatırımlarınızı korur.

ES

Nuestro experto personal de servicio posventa está a su servicio las 24 horas del día, los 7 días de la semana para todas sus necesidades. Para su satisfacción permanente, brinda un diagnóstico preciso e intervención a todos sus problemas a la mayor brevedad posible con soporte instantáneo de conexión remota y servicio en el sitio. GRUPO AES protege sus inversiones con servicios postventa para una producción ininterrumpida.



REMOTE AND ON-SITE SERVICE SERVICES

UZAKTAN VE YERİNDE
SERVIS HİZMETLERİ

SERVICIOS DE MANDO A
DISTANCIA Y LUGAR



TRAINING AND INSTALLATION SERVICES

EĞİTİM VE KURULUM
HİZMETLERİ

SERVICIOS DE FORMACIÓN E
INSTALACIÓN



SPARE PARTS AND SALES SUPPORT

YEDEK PARÇA VE
SATIŞ DESTEĞİ

PIEZAS DE RECAMBIO Y
SOPORTE DE VENTA



UNINTERRUPTED CONNECTION WITH WEB PLATFORM

WEB PLATFORMU İLE
KESİNTİSİZ BAĞLANTI

CONEXIÓN PERMANENTE
CON LAS PLATAFORMA WEB

24/7 0850 22 77 AES
CALL CENTER
CENTRO DE LLAMADAS



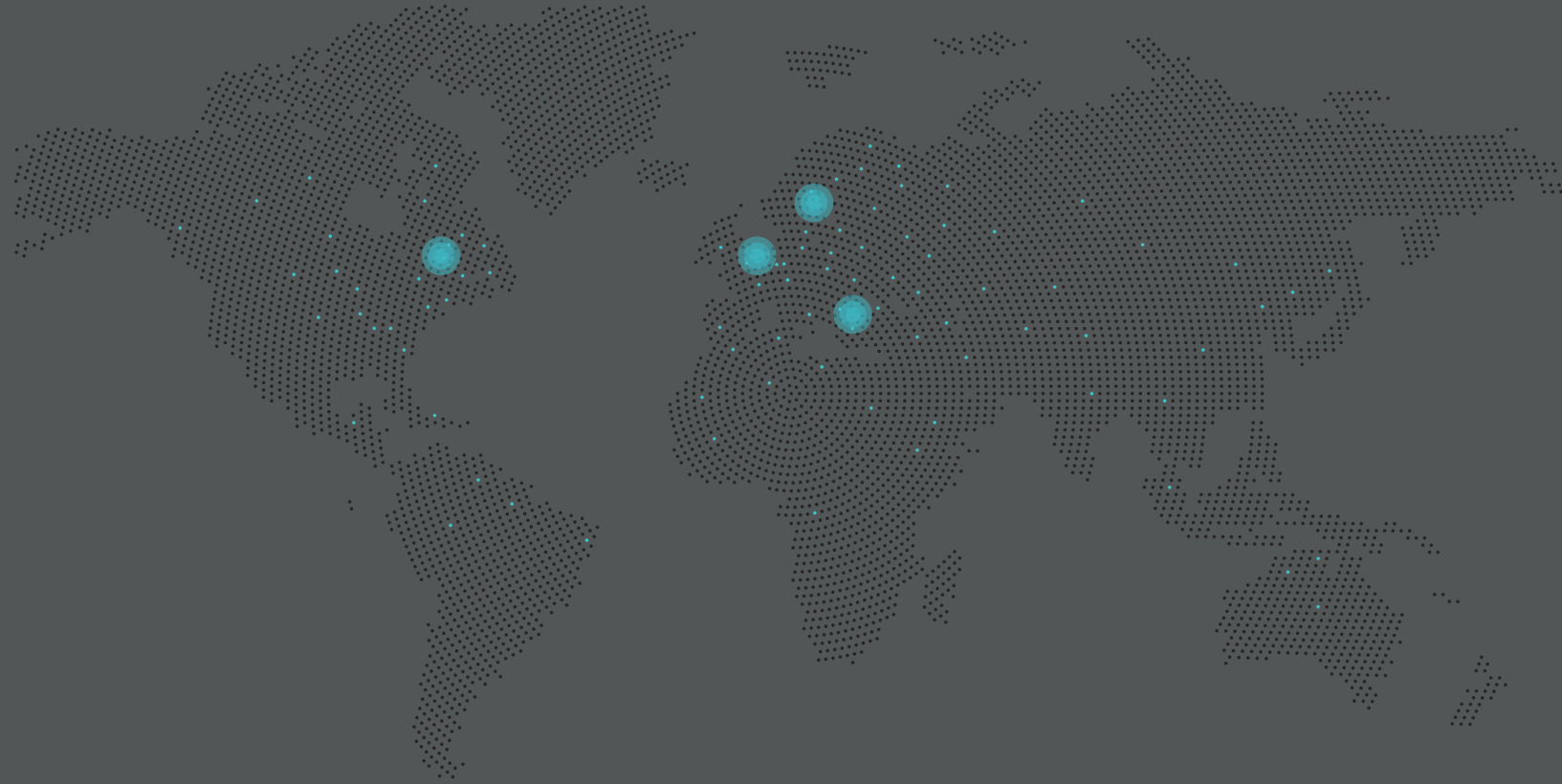

AES HEADQUARTER

NOSAB Şeftali Cd.
118. Sk. No:4 Nilüfer
16140 Bursa / TÜRKİYE

Tel : +90 224 443 33 90
Fax : +90 224 443 29 65

info@aesgroup.com.tr
www.aesgroup.com.tr



AES EUROPE BVBA

Kruisbosstraat
2b2-6186, 3740
Bilzen / BELGIUM

Tel : +32 89 81 1505
Fax : +32 89 81 1505

info@aesgroupeurope.com
www.aesgroupeurope.com



AES AMERICA INC.

4508-B Westinghouse
Blvd.Charlotte, 28273
NC USA

Tel : +1 704 817 7037
Fax : +1 704 817 7036

info@aesgroupamerica.com
www.aesgroupamerica.com



AES GROUP MACHINERY UK LTD

Unit 6, Dakota Business Park, Dakota
Way, Burscough, Lancashire L40 8AF
UNITED KINGDOM

Tel : +44 800 083 8844
Fax : +44 800 083 8855

info@aesgroupukmachinery.co.uk
www.aesgroupukmachinery.co.uk



www.aesgroup.com.tr